



USER MANUAL

m² multi AAD

It could save you...
More than you think...



CONTENTS

	CONTENTS				
	WARNING				
1.	Introduction	5.	Controls	9.	Maintenance
1.1.	General description	5.1.	Control basics	9.1.	Cutter replacement
1.2.	Operating principle	5.2.	Switching the device on and off	9.2.	Filter replacement
		5.2.1.	Switch on sequence	9.3.	Battery
		5.2.2.	Switch off sequence	9.4.	Annual inspection
2.	m² multi description	5.3.	Changing the profile	9.4.1.	Inspection procedure
2.1.	Construction	5.3.1.	Profile changes sequence		
2.2.	Processing unit	5.4.	INFO	10.	Technical data
2.3.	Control Unit	5.4.1.	Access INFO with device ON	10.1.	Basic technical data
2.4.	Cutter	5.4.2.	Access INFO with device OFF	10.2.	Device service life
		5.4.3.	Meaning of individual letters	10.3.	Cutter service life
3.	Profiles	5.4.4.	Gravity index	10.4.	Warranty
3.1.	Description	5.5.	Error messages		
3.2.	List of profiles	5.5.1.	List of errors and their numbers	11.	Disclaimer
3.2.1.	STUDENT (Stu)				
3.2.2.	INTERMEDIATE (Int)	6.	SEtUP	12.	Appendices
3.2.3.	PROFESSIONAL (Pro)	6.1.	SCALE setting description	12.1.	X-RAY Card
3.2.4.	CANOPY PILOTING (CPi)	6.1.1.	SCALE setting sequence		
3.2.5.	TANDEM (TAn)	6.2.	ProFILE setting description		
3.3.	Profile charts	6.2.1.	ProFILE setting sequence		
3.4.	Profile parameters	6.3.	AdJUSt setting description		
3.5.	AdJUSt description and use	6.3.1.	AdJUSt settings sequence		
4.	Operating mode	7.	Important limits and limit modes		
4.1.	Description	7.1.	Use in pressurized aircraft		
4.2.	List of modes	7.2.	Altitude lock		
4.2.1.	BASIC mode	7.3.	Water jumps		
4.2.2.	OFFSEt HI mode	7.4.	Instructions for the pilot		
4.2.3.	OFFSEt LO mode	7.5.	Important operation principles		
4.3.	Examples of using modes				
4.3.1.	BASIC mode - example	8.	Installation		
4.3.2.	OFFSEt HI mode - setting and example	8.1.	Installation procedure		
4.3.2.a.	OFFSEt HI mode - sequence	8.2.	Securing closing loop		
4.3.3.	OFFSEt LO mode - setting and example				
4.3.3.a.	OFFSEt LO mode - sequence				

WARNING

Skydiving is a dangerous activity that can result in serious or even fatal injury. To reduce these risks, it is necessary to have training and experience. Using the m² multi automatic activation device when skydiving can significantly reduce these risks. Never rely solely on the m² multi, since it is not the primary tool for opening of your parachute. Keep in mind that the m² multi is an electronic device and, just like any other equipment, it can fail. In some collisions the m² multi may even cause death. Read the instructions thoroughly before using the device. The device is not designed for PARAGLIDING, PARASCENDING, PARASAILING and BASE JUMPING. Even a flawless operation of the m² multi cannot ensure proper operation of the parachute kit, i.e. the harness with container, reserve parachute and other equipment. The m² multi device is only responsible for cutting the reserve parachute closing loop that is properly pulled through the cutter!!!

The specified activation altitude (AGL) of the m² multi is based on a skydiver in a stable body position. If the skydiver is in another orientation, or unstable, this may result in pressure changes that cause the m² multi to activate above the specified altitude (AGL). To avoid premature activation of the m² multi the skydiver should be in a stable body position and comply with the recommended altitudes (AGL) for main canopy deployment.

In addition, the skydiver should be aware that it is possible to exceed the specified limits under canopy and cause the m² multi to activate. The Gravity Index is designed to show you how close you are to activation of the device under canopy, and we recommend that users become familiar with this feature (see chapter 5.4.3.).

I. Introduction

1.1. General description

Thank you for purchasing the **m² multi** AAD and we hope that you never find yourself in a situation in which you would need to use it. Simply switch on the **m² multi** in the chosen profile before the first jump and it will quietly guard your safety from that moment until it is switched off again.

The "AAD" Automatic Activation Device is an automatic electronic safety device. The **m² multi** device continuously checks that the skydiver is not too close to the ground without an open and functional parachute. It ensures the fall rate and altitude of the skydiver. If the **m² multi** evaluates the situation as dangerous for the skydiver, its cutter automatically cuts the reserve parachute closing loop and thus initiates the sequence of reserve parachute deployment. It is designed and manufactured on the basis of the latest findings focused on sport skydiving and its functions fully comply with the requirements of current skydiving sport.

Professional engineers who are themselves excellent skydivers participated in its development. The device has five different profile settings: STUDENT, INTERMEDIATE, PROFESSIONAL, CANOPY PILOTING and TANDEM. When switched on, the **m² multi** works fully automatically, without any user intervention.

1.2. Main advantages

The main advantages of the **m² multi** device are:

- ultra low power design - no battery replacement necessary for the service life duration
- service life 15 years + 6 months without the need to perform the prescribed servicing by the manufacturer
- compact smooth rounded metal construction
- minimum thickness of the body and the control unit
- water resistance up to 2m in salt or fresh water
- simple operation and many sophisticated additional features
- special flat cutter design with a knife to cut the closing loop



1.3. Operating principle

The **m² multi** is an electronic automatic activation device, operating on the principle of pressure reading. The primary means for detecting the altitude and fall rate is a pressure sensor. The altitude is calculated based on the difference between two atmospheric pressures. The pressure at current altitude and pressure on landing location "GROUND ZERO". The pressure on the landing location is measured and set after switching on the device during calibration. This pressure is automatically adjusted by a change in barometric pressure during the day without the need for user intervention. The **m² multi** checks the ambient barometric pressure every 32 seconds and it determines whether the aircraft has taken off. If yes, it begins to monitor the skydiver's altitude and fall rate. The pressure sensor measures the atmospheric pressure 8x per second in free fall.

The information collected is evaluated by means of a microprocessor and ingenious software and it is converted to real fall rate and altitude. Thanks to this, the **m² multi** device is capable of meeting the preset criteria of fall rate in combination with altitude above the landing location, cut the reserve parachute closing loop by means of the cutter and thus initiate the deployment sequence. The device is activated only in the case the preset criteria are met; the criteria differ depending on the set profiles - STUDENT (Stu), INTERMEDIATE (Int), PROFESSIONAL (Pro), CANOPY PILOTING (Cpi) and TANDEM (Tan).

2. m² multi description

2.1. Construction

The **m² multi** is designed to best meet the requirements for durability and correct operation in all situations. It strives not to restrict the skydiver. It works with minimum power consumption, which allows it to maintain sufficient capacity of the energy source for its entire service life without having to replace the battery. It is built inside a minimum-size cover and thus gives the skydiver the possibility to open the reserve parachute without using the manual handle. The **m² multi** consists of a processing unit with the battery, processor, electronic circuits and a pressure sensor. The processing unit is connected to the control unit by means of a cable; the control unit contains a multifunction display and control button. The cutter connected in the processing unit body via a connector as a removable part of the device.

2.2. Processing unit

The body of the processing unit is made of aluminum alloy and its surface is coated. The front face of the unit bears the **m² multi** logo and on the back there is the identification label. Between the cables on the top side there is a filter. The whole body is watertight.

The identification label indicates the following information:

- SN (Serial Number), unique serial number
- MFD (Manufacture Date), year and month of manufacture
- **m² multi** AAD, commercial designation
- Made in Czech Republic and EU, country of origin
- logo and other specifications required for such a device



2. m² multi description

2.3. Control unit

The body of the control unit is made of stainless steel and is connected to the processing unit by a flexible cable. The unit has a display for the various icons and a control button.

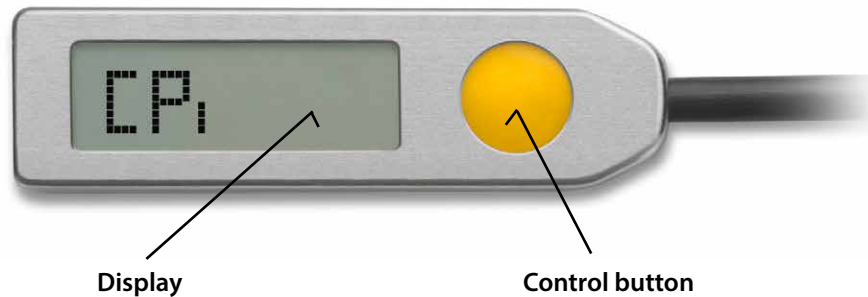

Only press the control button with the pad of your finger!

2.4. Cutter

The cutter is made of stainless steel and cuts the reserve parachute closing loop, if necessary. Its shape allows it to be firmly fixed between the reserve parachute container flaps and it prevents the cutter body from turning around its longitudinal axis. It is highly scratch resistant. It is connected to the main unit via a flexible cable and a connector. The connector is completely inserted into the processing unit and is secured with a locking screw to prevent accidental removal.

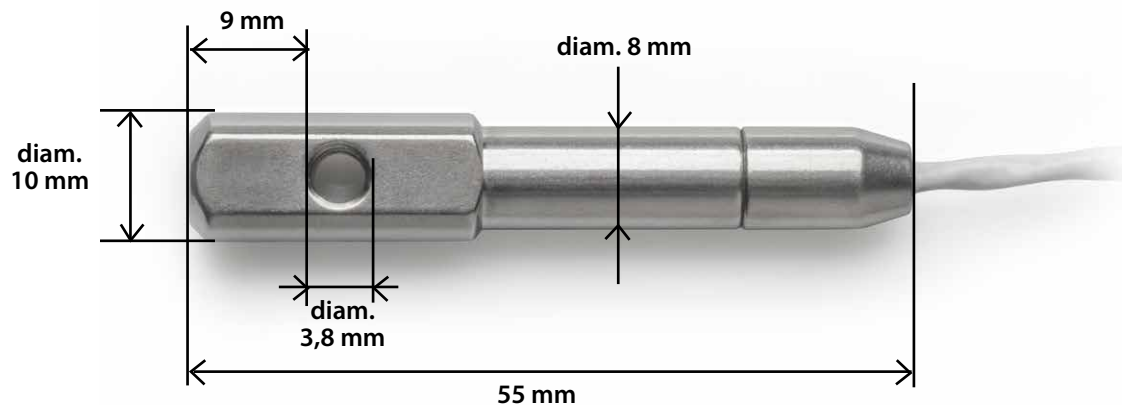

3. Profiles

3.1. Description

Profile is a set of parameters that determine the conditions for activation of the **m² multi** device. The most important parameters are the activation altitude and the fall rate. The parameters of the individual profiles are fixed. The user may select and set a profile depending on his skills, used parachute and sports performance or focus. The profile setting is permanent and may be changed in the SETUP menu.

3.2. List of profiles

STUDENT (Stu)

INTERMEDIATE (Int)

PROFESSIONAL (Pro)

CANOPY PILOTING (CPi)

TANDEM (TAn)

3.2.1. STUDENT (Stu)

The STUDENT profile is designed for basic training of students and AFF. It is activated when the height above the landing location is lower than **approx. 330m / 1 100ft** and fall rate is higher than **approx. 13m.s⁻¹ / 29mph**. The altitude lock opens at **approx. 450m / 1 475ft**. The device does not activate when below **approx. 60m / 195ft**. The activation zone is thus in the range of **approx. 330m to 60m / 1 100ft to 195ft** above the landing location.

Warning:

The speed of **approx. 13m.s⁻¹ / 29mph** may be also reached with a fully functional parachute!

If the student-skydiver does not go on with the jump and lands on board the aircraft, switch off the **m² multi** device always in the STUDENT setting. If this is not possible, the aircraft must not descend faster than **approx. 13m.s⁻¹ / 29mph**.

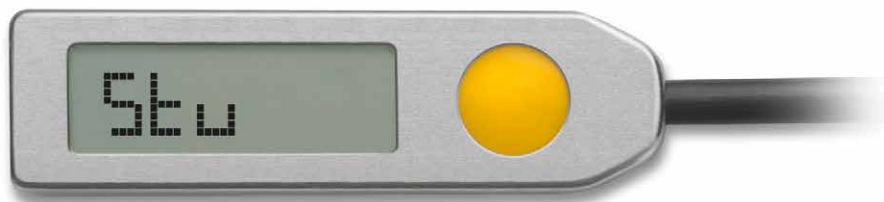

3. Profiles

3.2.2. INTERMEDIATE (Int)

The INTERMEDIATE profile is designed for basic training of advanced students and AFF. It is activated when the height above the landing location is lower than **approx. 330m / 1 100ft** and fall rate is higher than **approx. 20m.s⁻¹ / 45mph**.

The altitude lock opens at **approx. 450m / 1 475ft**. The device does not activate when below **approx. 60m / 195ft**. The activation zone is thus in the range of **approx. 330m to 60m / 1 100ft to 195ft** above the landing location. It is the recommended setting for students after completing the first ten jumps. It is solely upon the decision of the instructor to determine the setting and suitability of its use for a particular student.

Warning:

The speed of **approx. 20m.s⁻¹ / 45mph** may be also reached with a fully functional parachute!

If the student-skydiver does not go on with the jump and lands on board the aircraft, switch off the **m² multi** device always in the INTERMEDIATE setting. If this is not possible, the aircraft must not descend faster than **approx. 20m.s⁻¹ / 45mph**.



3.2.3. PROFESSIONAL (Pro)

The PROFESSIONAL profile is the most commonly used setting of the device. Is designed for experienced skydivers. It is activated when the height above the landing location is lower than **approx. 270m / 885ft** and fall rate is higher than **approx. 35m.s⁻¹ / 78mph**. The altitude lock opens at **approx. 450m / 1 475ft**. The device does not activate when below **approx. 100m / 330ft**. The activation zone is thus in the range of **approx. 270m to 100m / 885ft to 330ft** above the landing location.

Warning:

The speed of **approx. 35m.s⁻¹ / 78mph** may be also reached with a fully functional parachute!

If you are using a high-performance parachute, check the GRAVITY index! (Section 5.4.4.).

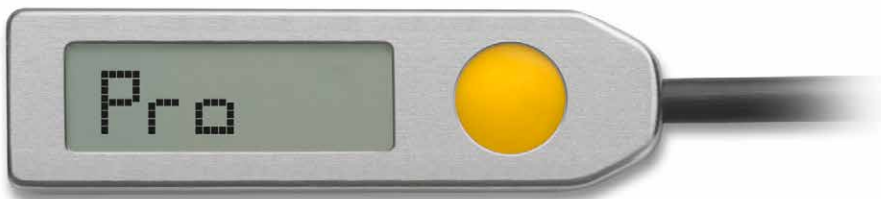

3. Profiles

3.2.4. CANOPY PILOTING (CPi)

The CANOPY PILOTING profile is primarily intended for the Canopy Piloting sports discipline. The profile is used only for the most experienced pilots with extremely quick parachutes and vast experience. It is activated when the height above the landing location is lower than **approx. 270m / 885ft** and fall rate is higher than **approx. 45m.s⁻¹ / 101mph**. The altitude lock opens at **approx. 450m / 1 475ft**. The device does not activate when below **approx. 150m / 490ft**. The activation zone is thus in the range of **approx. 270m to 150m / 885ft to 490ft** above the landing location.

Warning:

The speed of **approx. 45m.s⁻¹ / 101mph** may be also reached with a fully functional parachute!

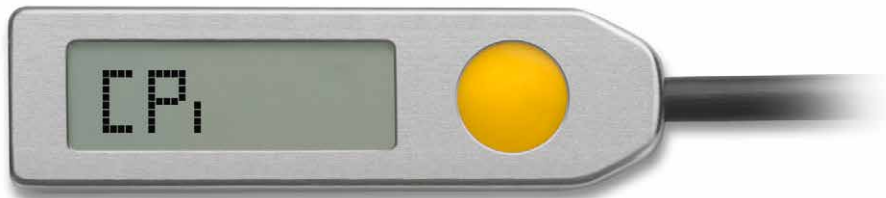

3.2.5. TANDEM (TAn)

The TANDEM profile is designed for tandem kits. It is activated when the height above the landing location is lower than **approx. 610m / 2 000ft** and fall rate is higher than **approx. 35m.s⁻¹ / 78mph**. The altitude lock opens at **approx. 900m / 2 950ft**. The device does not activate when below **approx. 100m / 330ft**. The activation zone is thus in the range of **approx. 610m to 100m / 2 000ft to 330ft** above the landing location.

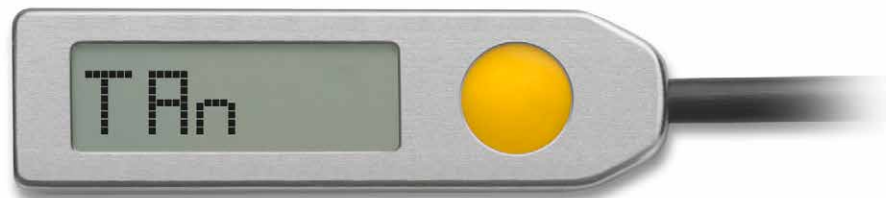

3. Profiles

3.3. Profile charts

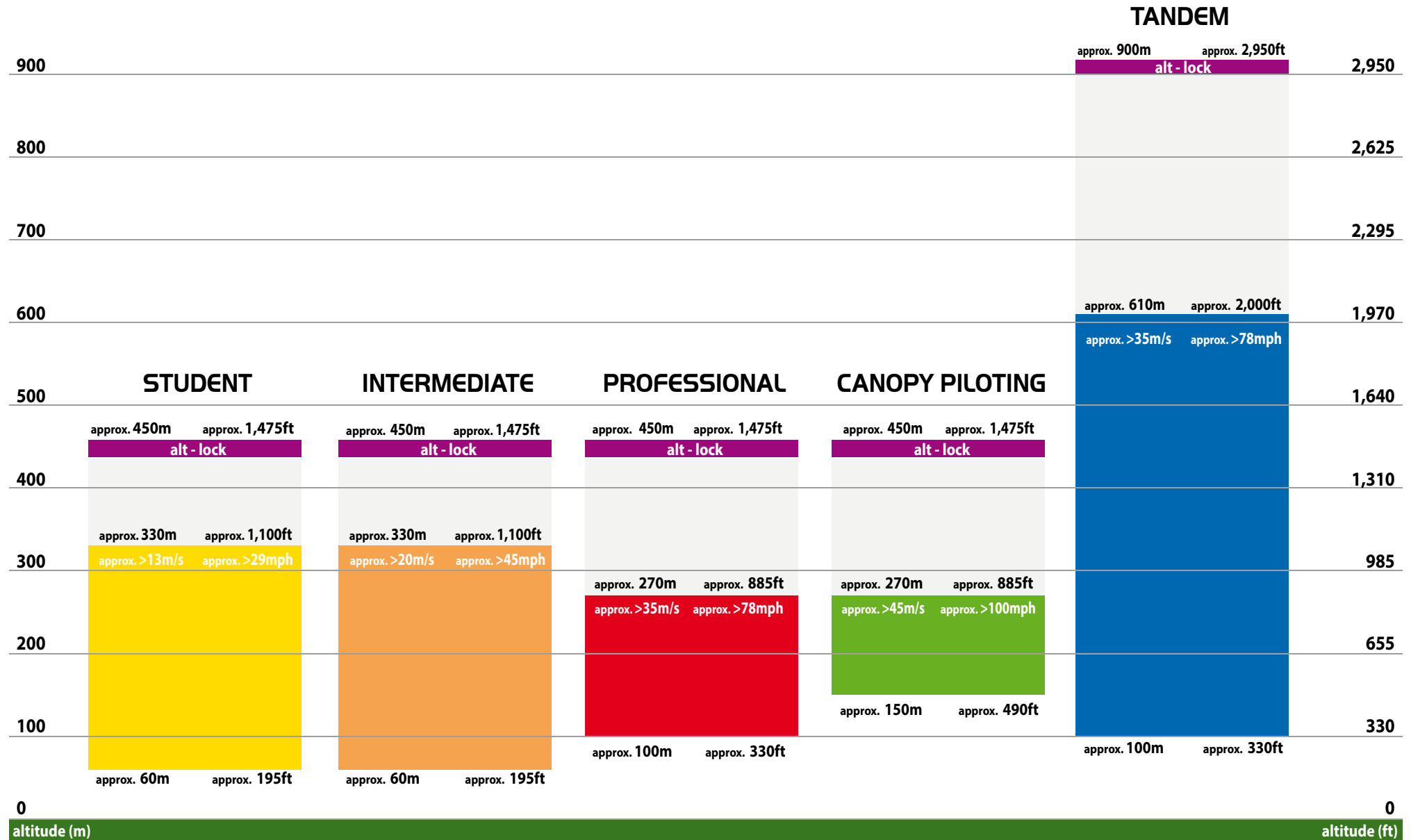

Parameters in chapter 3.4.



3. Profiles

3.4. Profile parameters

3.4.1. m² multi STUDENT (Stu)

Altitude lock (Alt-Lock)	approx. 450m / 1 475ft
Activation zone begins (Top)	approx. 330m / 1 100ft
Activation zone ends (Bottom)	approx. 60m / 195ft
Activation speed	approx. > 13m.s ⁻¹ / 29mph

3.4.2. m² multi INTERMEDIATE (Int)

Altitude lock (Alt-Lock)	approx. 450m / 1 475ft
Activation zone begins (Top)	approx. 330m / 1 100ft
Activation zone ends (Bottom)	approx. 60m / 195ft
Activation speed	approx. > 20m.s ⁻¹ / 45mph

3.4.3. m² multi PROFESSIONAL (Pro)

Altitude lock (Alt-Lock)	approx. 450m / 1 475ft
Activation zone begins (Top)	approx. 270m / 885ft
Activation zone ends (Bottom)	approx. 100m / 330ft
Activation speed	approx. > 35m.s ⁻¹ / 78mph

3.4.4. m² multi CANOPY PILOTING (Cpi)

Altitude lock (Alt-Lock)	approx. 450m / 1 475ft
Activation zone begins (Top)	approx. 270m / 885ft
Activation zone ends (Bottom)	approx. 150m / 490ft
Activation speed	approx. > 45m.s ⁻¹ / 101mph

3.4.5. m² multi TANDEM (TAn)

Altitude lock (Alt-Lock)	approx. 900m / 2 950ft
Activation zone begins (Top)	approx. 610m / 2 000ft
Activation zone ends (Bottom)	approx. 100m / 330ft
Activation speed	approx. > 35m.s ⁻¹ / 78mph



3. Profiles

3.5. AdJUST description and use

The individual profiles and their activation parameters are fixed in the process of manufacture. Some users may prefer a higher activation altitude, which gives them more time to deal with an emergency in case of activation. In some countries or at some dropzones a higher activation altitude may be required by local regulations. The AdJUST function allows the user to modify the current profile and increase the activation altitude in case this is considered necessary. In the current profile the "Top" activation altitude may be increased in several steps, A1 to A9. The individual increments are **approx. 30 m / 100 ft**. The maximum increase in the activation altitude is **approx. +270 m / 900 ft**. The AdJUST setting is permanent and is displayed together with the current profile on the control unit display.

Warning:

- **The altitude lock increases adequately according to the selected step A1 to A9! (Section 7.2.)**
- **Take care to open the main parachute in time as you may quickly reach the activation altitude!**

Procedure of setting the AdJUST function can be found in Section 6.3.



4. Operating mode

4.1. Description

The **m² multi** device may be switched on in several modes. The mode is selected when the device is switched on and remains active until it is switched off again - the selection is not permanent. The various modes are used to distinguish the type of jump and they determine the device behavior. BASIC mode is used most often - when the skydiver performs the jump at an airport (dropzone) and the aircraft take-off point and the landing location are thus the same - they are at the same elevation. OFFSEt mode must be always used when the take-off and landing locations are at different elevations. OFFSEt mode allows the user to enter the elevation difference between the aircraft take-off point and the landing location during the switch on sequence. If the device is switched on in BASIC mode, the current profile is shown on the display. If the device is switched on in OFFSEt mode, the display shows "offset", the first letter of the profile, the entered elevation difference between the aircraft take-off point and the landing location, and the units icon. When the button is depressed, the full description of the current profile is displayed.

4.2. List of modes

- **BASIC** It is used when the skydiver takes-off and lands at the same place.
- **OFFSEt HI** It is designed for situations when the landing location is higher (elevation) than the elevation at which the device was switched on.
- **OFFSEt LO** It is designed for situations when the landing location is lower (elevation) than the elevation at which the device was switched on.

4.2.1. BASIC - mode

The BASIC mode shall be used always, when the skydiver starts (take-off point of the aircraft), and lands at the same place, usually the drop zone and does not need to change the device parameters due to higher or lower landing location. The landing location is in this case at the same elevation as

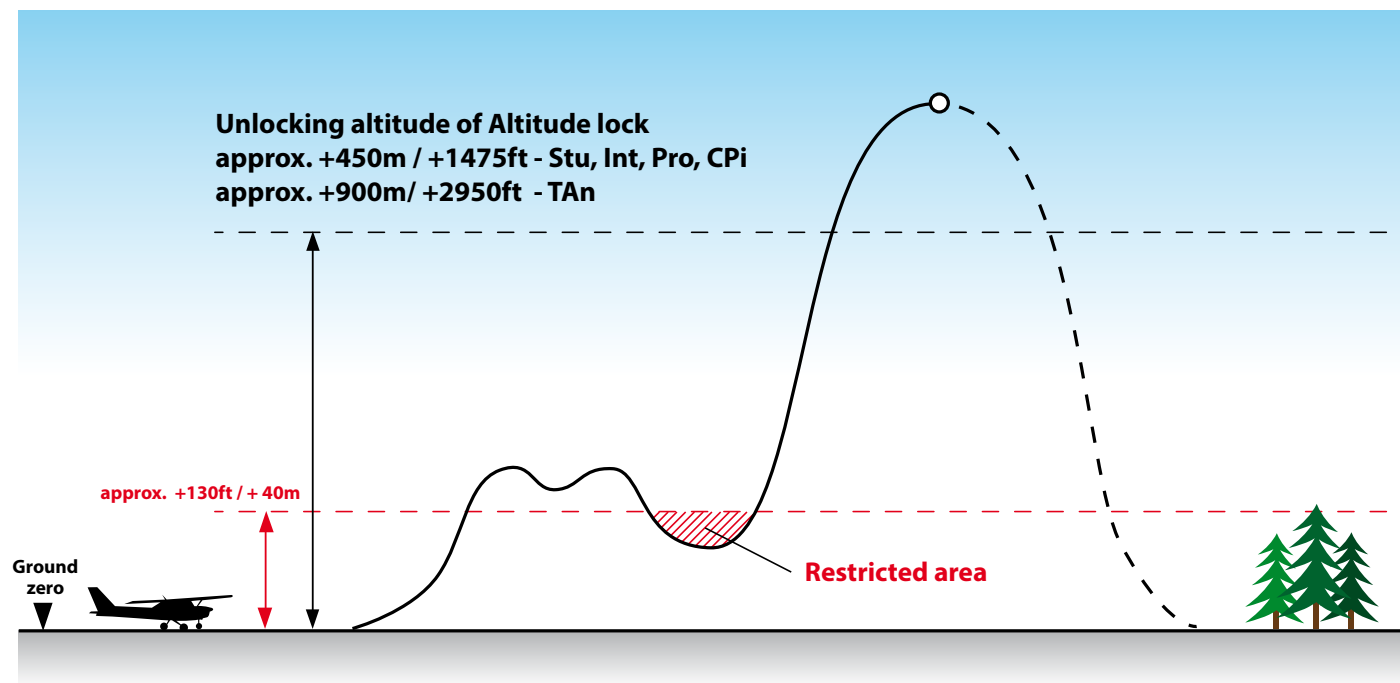

the take-off point of the aircraft, where the device was switched on. Always switch on the device at the landing location. The **m² multi** requires the plane to immediately climb **approx. 40m/130ft** above Ground Zero for a correct detection of start-up and remain above this altitude until the skydivers jump off. In the next phase of the flight it is necessary to exceed the Altitude lock (watch out for increasing the unlocking altitude, see Section 6.3.) according to the preset device profile (**approx. 450m/ 1 475ft - Stu, Int, Pro, Cpi, (ca 900m / 2 950ft - Tan)** to unlock the device.

4. Operating mode

4.2.2. OFFSEt HI - mode

OFFSEt HI mode is designed for situations when the landing location is higher (elevation) than the elevation at which the device was switched on (take-off point of the aircraft). It is necessary to set the elevation difference of the landing location in the range of **approx. +/- 999m / +/- 2 990ft**. **Reminder: This is a temporary setting for one jump only!** The settings can only be done when switching on the device. **When using the OFFSEt HI mode, the altitude at which the altitude lock opens relates to the preset landing location elevation. It is also necessary to bear this fact in mind in case of an emergency situation!**

Switch on the device at the take-off point of the aircraft. For correct operation of the **m² multi** it is necessary to preset the elevation difference between the landing location and the take-off location. Enter the numeric value of the difference between the parachutist landing location and the aircraft take-off point. The altitude lock is in this case relates to the landing location, i.e. according to the profile either **approx. +450m / +1 475ft** for profiles Stu, Int, Pro and Cpi or about **+900m / +2 950ft** for profile Tan plus the specified elevation difference. In such case, the **m² multi** requires the plane to immediately climb **approx. 40m / 130ft** above the take-off point for a correct detection of start-up and remain above this altitude. After reaching the preset altitude plus **approx. 40m / 130ft** and exceeding it, the aircraft shall remain above this level until the skydivers jump off. If the skydiver lands at the preset altitude, the device switches off automatically. If the device does not switch off automatically, do it manually after landing. Switch the device on only before the following jump. This ensures perfect calibration and operation of the **m² multi** device.

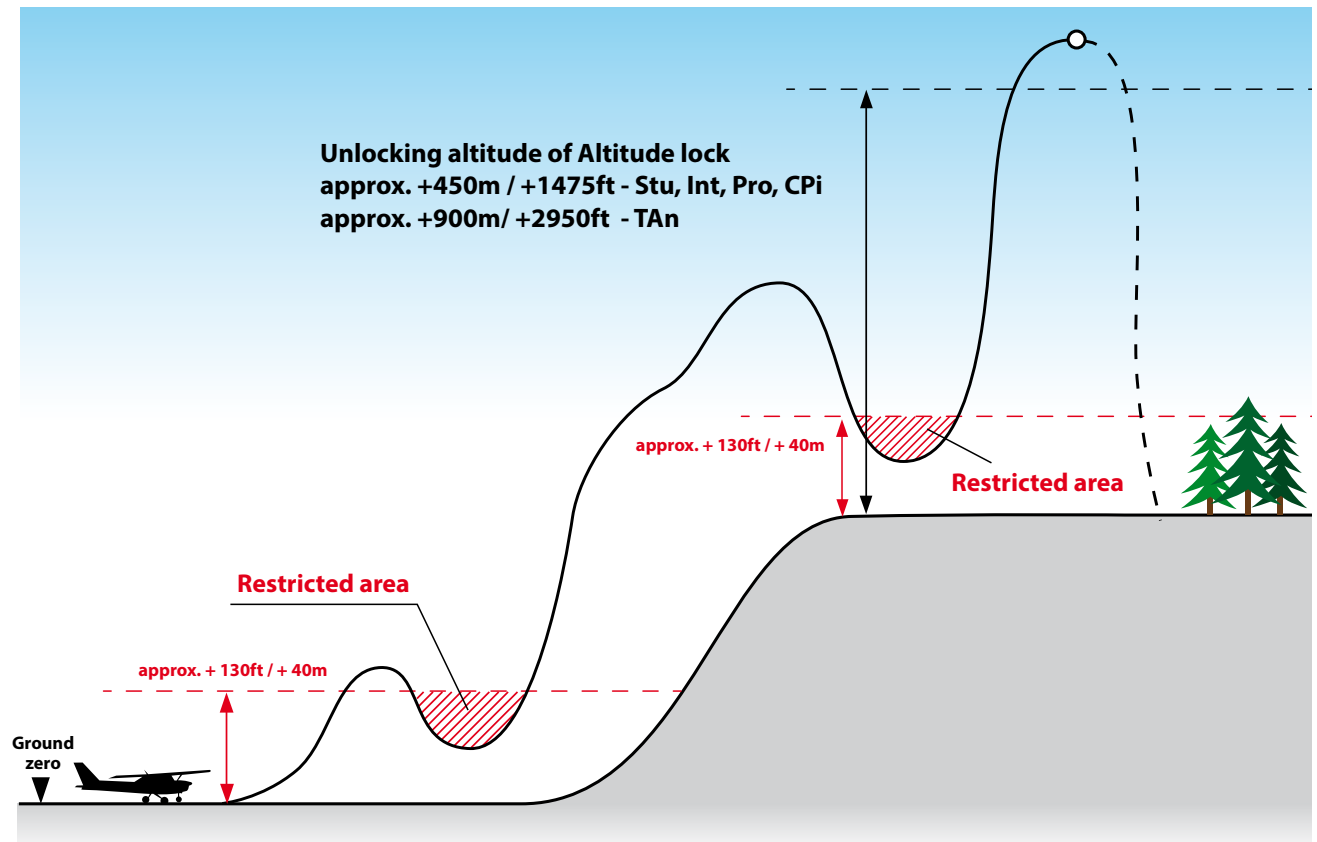

4. Operating mode

4.2.3. OFFSEt LO - mode

OFFSEt LO mode is designed for situations when the landing location is lower (elevation) than the elevation at which the device was switched on. In this mode, you can set the elevation difference of the landing location in the range of **approx. +/- 999m / +/- 2 990ft**. **Reminder: This is a temporary setting for one jump only!** The settings can only be done when switching on the device. **When using the OFFSEt LO mode, the altitude at which the altitude lock opens relates to the preset landing location elevation. It is also necessary to bear this fact in mind in case of an emergency situation!**

Switch on the device at the take-off point of the aircraft. For correct operation of the **m² multi** it is necessary to preset the elevation difference between the landing location and the take-off location. Enter the numeric value of the difference between the parachutist landing location and the aircraft take-off point. The altitude lock is in this case relates to the landing location, i.e. according to the profile either **approx. +450m / +1 475ft** for profiles Stu, Int, Pro and Cpi or **approx. +900m / +2 950ft** for profile Tan minus the specified elevation difference. In such case, the **m² multi** requires the plane to immediately climb **approx. 40m/130ft** above the take-off point for a correct detection of start-up and remain above this altitude for at least 90 seconds. After these 90 seconds it is possible to descend below the take-off altitude but not below the preset landing location altitude plus **approx. 40m / 130ft**. If the skydiver lands at the preset altitude, the device switches off automatically. If the device does not switch off automatically, do it manually after landing. Switch the device on only before the following jump. This ensures perfect calibration and operation of the **m² multi** device.

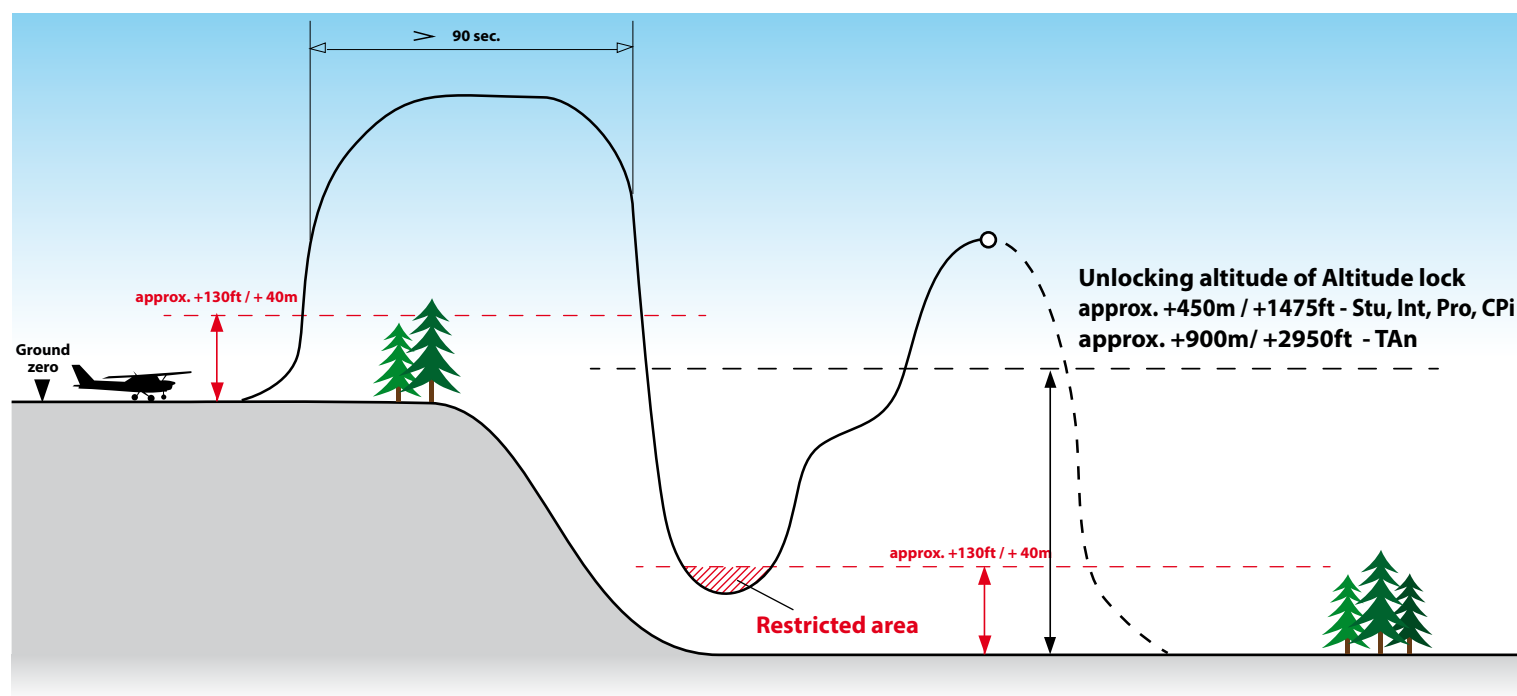

4. Operating mode

4.3. Examples of using modes

4.3.1. BASIC mode - example

BASIC mode shall be used always, when the skydiver takes off and lands on the same location, usually drop zone (takes off and lands at the same elevation). The display shows:



Switched on in the BASIC mode with STUDENT (Stu) profile

4.3.2. OFFSEt HI mode - setting and example

Limit warning! The OFFSEt HI mode can only be used locally on the same isobar!

Example: The landing location is about 250m above the point at which the device was turned on (take-off point).

Briefly press the yellow button on the control unit, GO-ON sign appears (for 2 seconds). Do not hold the button, depress it only briefly!!!

During the time the GO-ON sign is displayed, preferably immediately after it comes on, depress the yellow button briefly once again. The GO-ON sign appears again. After the yellow button is depressed again (GO-ON sign displayed), the last preset PROFILE can be seen on the display (Stu, Int, Pro, Cpi, Tan). DO NOT CONFIRM the selected PROFILE and wait for OFFSEt function to show; confirm this function by pressing the button.

The display shows +HI (increased landing elevation). Confirm +HI by pressing the yellow button at the moment the required function is indicated on the display. (Note: If the device had already been set for OFFSEt in the given mode +/-, the display shows the last selected setting for two seconds.)

If the original setting is not confirmed by depressing the button, the display will show the initial letter of the set PROFILE (Stu, Int, Pro, Cpi, Tan), then the plus sign (+) and in two one-second intervals it displays the numbers to allow exact setting of the required altitude. The first number is hundreds of meters, followed by tens and single meters. After entering the required offset, the device calibrates. The initial letter of the PROFILE remains on the display and above it is the sign offset followed by a plus sign (+) and the set meters. For a better control of the selected PROFILE, it is possible to press the button once, the whole set PROFILE is shown and above it is the offset sign, after four seconds the GO-OFF sign appears in case you intend to switch off the device completely, and the INFO menu also comes on that allows access to the information menu.



Switched on in the OFFSEt HI +250m mode with STUDENT (Stu)

4. Operating mode

4.3.2.a. OFFSEt HI mode - sequence

The landing location is about 1 000ft above the point at which the device was turned on (take-off point).

After a completed jump in the OFFSEt mode, the device switches off automatically!

If the device does not switch off automatically, do it manually after landing.

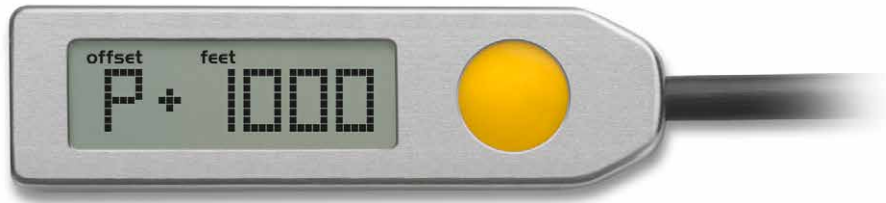

Example:
Switched on in the OFFSEt HI +1000ft mode with PROFESIONAL (Pro) profile

Switched on with OFFSEt +1000ft

blank LCD - device is off

click >> << wait

GO-ON

click >> << wait

GO-ON

click >> << wait

Pro

wait

offset feet OFFSEt

click >> << wait

offset + HI

click >> << wait

offset feet P+ 0500

wait

offset feet P+ _ _ _ _

wait

offset feet P+ 0 _ _ _

wait

offset feet P+ 1 _ _ _

click >> << wait

offset feet P+ 10 _ _

click >> << wait

offset feet P+ 100 _

click >> << wait

offset feet P+ 1000

click >> << wait

CAL

wait

offset feet P+ 1000

OK

Switched off with OFFSEt

offset feet P+ 1000

click >> << wait

offset Pro

wait

GO-OFF

click >> << wait

GO-OFF

click >> << wait

GO-OFF

click >> << wait

blank LCD - device is off

OK

4. Operating mode

4.3.3. OFFSEt LO mode - setting and example

Limit warning! The OFFSEt LO mode can only be used locally on the same isobar!

Example: The landing location is about **175 m below** the point at which the device was turned on (take-off point).

Briefly press the yellow button on the control unit, GO-ON sign appears (for 2 seconds). Do not hold the button, depress it only briefly!!! During the time the GO-ON sign is displayed, preferably immediately after it comes on, depress the yellow button briefly once again. The GO-ON sign appears again. After the yellow button is depressed again (GO-ON sign displayed), the last preset PROFILE can be seen on the display (Stu, Int, Pro, Cpi, Tan). DO NOT CONFIRM the selected PROFILE and wait for OFFSEt function to show; confirm this function by pressing the button. The display shows -LO (decreased landing elevation). Confirm -LO by pressing the yellow button at the moment the required function is indicated on the display. (Note: If the device had already been set for OFFSEt in the given mode +/-, the display shows the last selected setting for two seconds.) If the original setting is not confirmed by depressing the button, the display will show the initial letter of the set PROFILE (Stu, Int, Pro, Cpi, Tan), then the minus sign (-) and in two one-second intervals it displays the numbers to allow exact setting of the required altitude. The first number is hundreds of meters, followed by tens and single meters. After entering the required offset, the device calibrates. The initial letter of the PROFILE remains on the display and above it is the sign **offset** followed by a minus sign (-) and the set meters. For a better control of the selected PROFILE, it is possible to press the button once, the whole set PROFILE is shown and above it is the offset sign, after four seconds the GO-OFF sign appears in case you intend to switch off the device completely, and the INFO menu also comes on that allows access to the information menu.



Switched on in the OFFSEt LO -175m mode with STUDENT (Stu) profile

4. Operating mode

4.3.3.a. OFFSEt LO mode - sequence

The landing location is about **1000ft below** the point at which the device was turned on (take-off point).

After a completed jump in the OFFSEt mode, the device switches off automatically!

If the device does not switch off automatically, do it manually after landing.

Switched on with OFFSEt -1000ft

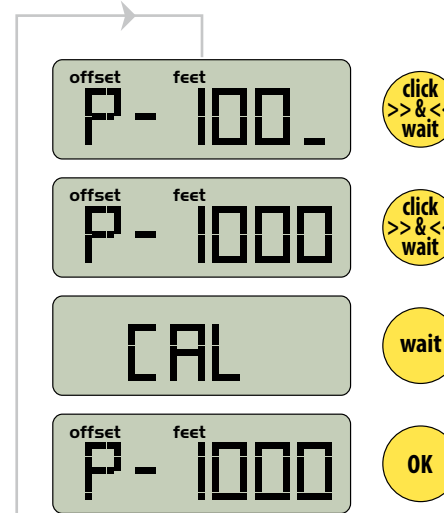
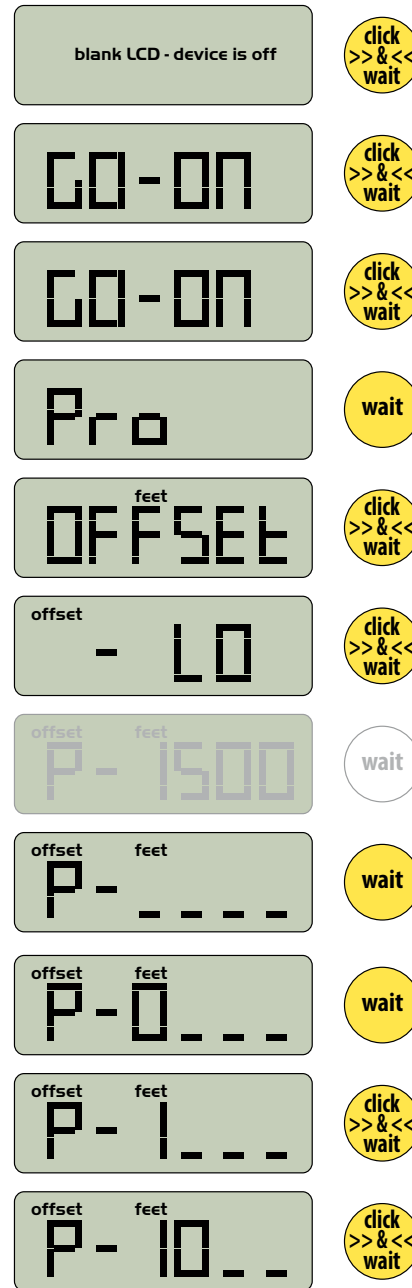

Switched off with OFFSEt

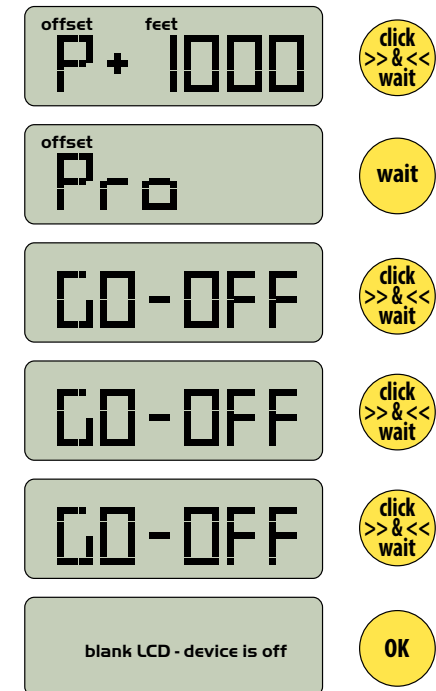

5. Controls

5.1. Control basics

Control of the **m² multi** device is very simple. The only control is the yellow button on the control unit (Section 2.3). Always depress the button shortly and release it immediately. Apart from the first time the button is pressed when the device is switched on, the button shall always be depressed when the relevant icon is displayed.

In case the button is not depressed shortly when the relevant icon is displayed, the switch-on sequence is interrupted. It is then necessary to start switch-on sequence from the beginning.

Never switch on the device on board the aircraft!

5.2. Switching the device on and off

Proceed according to the following charts:

5.2.1 Switch on sequence

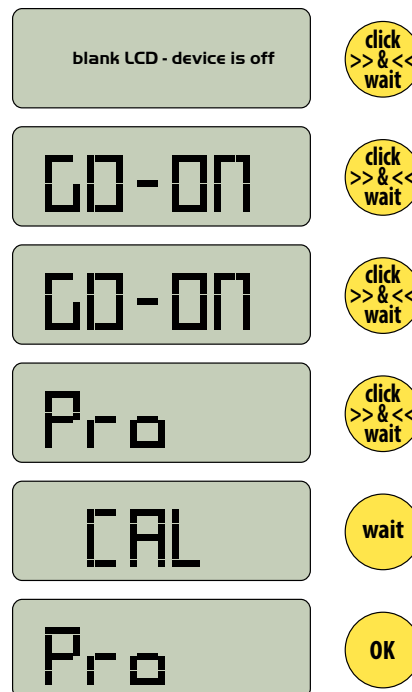

5.2.2 Switch off sequence

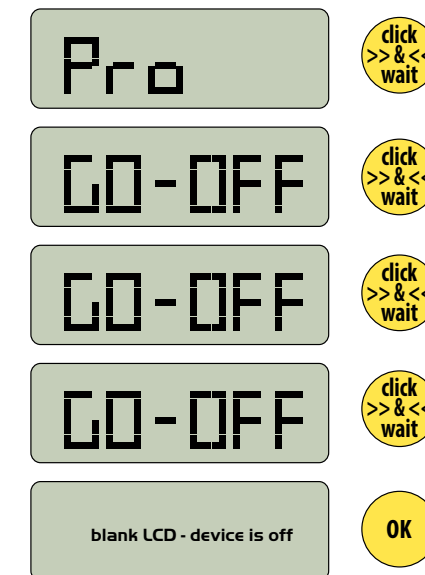

The device is OFF.

The device is now ON in the BASIC mode with PROFESSIONAL (Pro) profile.

5. Controls

5.3. Changing the profile

The possibility to change the profile of the device is one of its main advantages. Profiles can be changed arbitrarily, the **m² multi** does not have any limitations in this respect. Before using the device for a jump, check the currently set profile and make sure that you are familiar with the profile parameters, especially its top altitude limit of the activation zone (Section 3.4.).

5.3.1. Profile changes sequence

The following chart is an example of changing the Pro (PROFESSIONAL) profile to Stu (STUDENT) profile.

Change actual profile from PROFESSIONAL to STUDENT

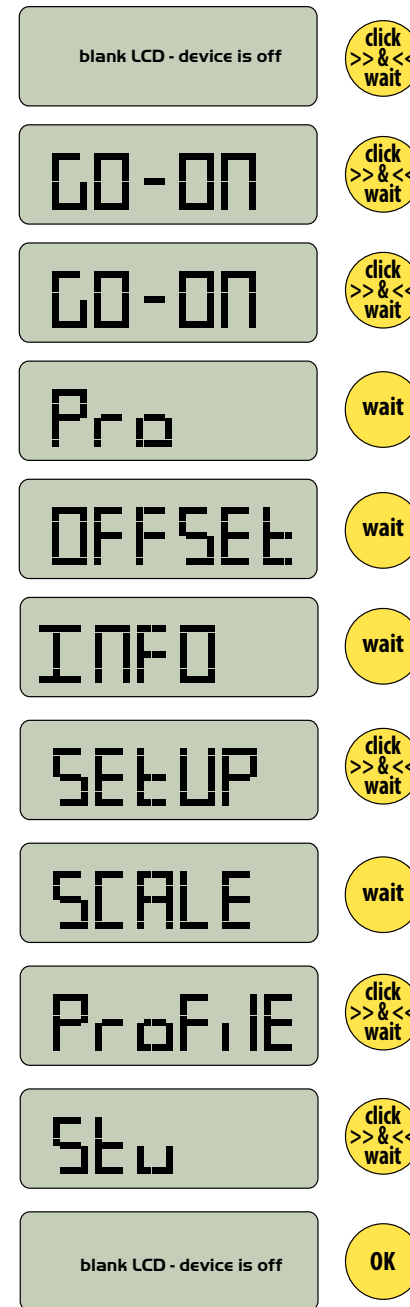

5. Controls

5.4. INFO

The INFO menu is accessible both when the device is switched on and off. All useful information is stored under individual letters.

Some information in the INFO menu is temporary and is **ONLY available only when the device is switched on and calibrated (5.2.1)**:

- **D** – Deployment altitude of the last jump (available after a completed jump until the device is switched off)
- **G** – Gravity index of the last jump (available after a completed jump until the device is switched off)
- **P** – Barometric pressure (to display the current pressure, the device must be switched on and calibrated)

5.4.1 Access INFO with device ON

Briefly press the yellow button on the control unit once, GO-ON sign appears (for 2 seconds). Do not hold the button, depress it only briefly! After two seconds the INFO sign appears, confirm it immediately by pressing the button. Afterwards, the individual letters begin to appear in two-second intervals - d, j, G, b, l, n, r, y, P. Wait for the required number and confirm it by pressing the button. Subsequently, the requested information is visible for a period of five seconds. After this period, the **m² multi** returns to its basic settings – switched on.

5.4.2 Access INFO with device OFF

Briefly press the yellow button on the control unit, GO-ON sign appears (for 2 seconds). Do not hold the button, depress it only briefly! During the time the GO-ON sign is displayed, preferably immediately after it comes on, depress the yellow button briefly once again. The GO-ON sign appears again. After the yellow button is depressed again (GO-ON sign displayed), the last preset PROFILE can be seen on the display (**Stu, Int, Pro, Cpi, Tan**). Do not press the button to confirm the profile, but wait for the OFFSET sign to appear, after two seconds the INFO sign appears, confirm it by depressing the button. Afterwards, the individual letters begin to appear in two-second intervals - **d, j, G, b, l, n, r, y, P**. Wait for the required number and confirm it by pressing the button. Subsequently, the requested information is visible for a period of five seconds. After this period, the **m² multi** returns to its original settings – switched off.

5.4.3. Meaning of individual letters

- d** - deploy altitude of the last jump
- J** - total number of jumps
- G** - Gravity index of the last jump
- b** - remaining battery capacity
- L** - remaining service life of the device (in days)
- n** - device serial number
- r** - firmware version
- Y** - year and month of manufacture
- P** - barometric pressure

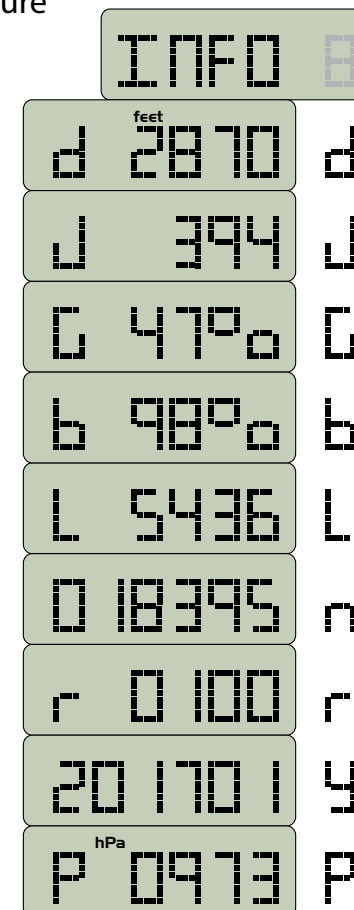

5. Controls

5.4.4. Gravity index

G - Gravity index is the percentage of the highest achieved fall rate in the activation zone during the last jump, when 100 % is the activation speed of the currently used device profile. After landing, the skydiver may check how close he was to the device activation limit during his flight on the parachute in the activation zone. This information is particularly important for Canopy Piloting, when the parachute pilots reach high speeds at minimum height above ground.

5.5. Error messages

An error message icon “**Err**” (ERROR) appears on the display. When this icon is visible, the **m² multi** shall not be used for jumps until the problem is resolved. To determine the type of error, proceed as follows: Briefly press the control button (2) on the control unit body (1). The display (2) then indicates the error number. If the “**Fail**” (FAILURE) icon appears on the display, the device is blocked, and it is impossible to switch it on or off. It must be send to the manufacturer for repair..

5.5.1. List of errors and their numbers

„**0**“ Internal integration error.

Solution: Send your device to the manufacturer for repair

“**1**“ Calibration error to GROUND ZERO. The range of the measured values is too large or the calibration value is out of limits.

Solution: Turn the **m² multi** device off and on again, the calibration shall start over.

“**2**“ Cutter error. The cutter is not connected properly, it is used or damaged.

Solution: Check the cutter or replace it with a new one.

“**4**“ Low battery voltage.

Solution: If the error occurs repeatedly, do not use the device, contact the dealer, distributor or manufacturer.

“**8**“ Pressure sensor error or out-of-range value.

Solution: Switch the **m² multi** off and on again. If the error occurs repeatedly, do not use the device, contact the dealer, distributor or manufacturer.

In case the above given solutions do not help or in case you are not sure how to proceed, contact the dealer, distributor or manufacturer.

6. SETUP

6. SETUP

The SETUP may be entered when switching on the device. SETUP allows access to the following device settings and their permanent change.

- **SCALE** (setting the units **meter / feet**)
- **ProFILE** (setting the profile **Stu, Int, Pro, CPi, TAn**)
- **AdJUST** (increase the activation height)

6.1. SCALE setting description

The setting is performed when switching on the device. Briefly press the yellow button on the control unit, GO-ON sign appears (for 2 seconds). **Do not hold the button, depress it only briefly!!!** During the time the GO-ON sign is displayed, immediately after it comes on, depress the yellow button briefly once again. The GO-ON sign appears again. After the yellow button is depressed again (GO-ON sign displayed), the last preset PROFILE can be seen on the display (Stu, Int, Pro, Cpi, Tan). **Do not press** the button to confirm the profile, but wait for the OFFSEt sign to appear, after two seconds the INFO sign appears and after another two seconds the **SETUP comes on** - confirm by depressing the button shortly.

SCALE is displayed as first, confirm it by shortly depressing the button.

By confirming access to the **SCALE** menu, the individual units begin to show in two-second intervals. The first unit to display is the METER, the second is the FEET.

Confirm the selected unit by pressing the button.

The unit is set when the device is switched on again.

6. SETUP

6.1.1. SCALE setting sequence

Change SCALE meter to feet

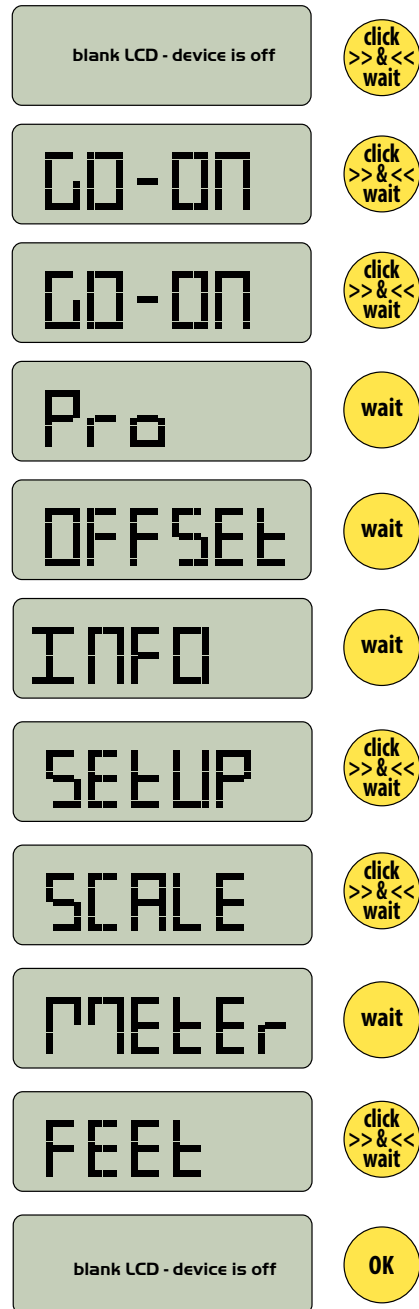

6. SETUP

6.2. ProFile setting description

The setting is performed when switching on the device. Briefly press the yellow button on the control unit, GO-ON sign appears (for 2 seconds). **Do not hold the button, depress it only briefly!!!** During the time the GO-ON sign is displayed, immediately after it comes on, depress the yellow button briefly once again. The GO-ON sign appears again. After the yellow button is depressed again (GO-ON sign displayed), the last preset PROFILE can be seen on the display (Stu, Int, Pro, CPi, TAn). **Do not press** the button to confirm the profile, but wait for the **OFFSEt** sign to appear, after two seconds the INFO sign appears and after another two seconds the **SETUP** comes on - **confirm by depressing** the button shortly.

SCALE is shown as first, do not confirm. Wait until ProFile is displayed, than confirm it by shortly pressing the button.

By confirming access to the **ProFile** menu, the individual profiles begin to show in two-second intervals.

Stu – Student,

Int – Intermediate,

Pro – Professional,

CPi – Canopy Piloting,

TAn – Tandem,

For profile parameters, see chapter 3.4.

Confirm the selected profile to be displayed by pressing the button.

After switching on the **m² multi**, the selected profile will be displayed on the display.

6. SETUP

Change actual profile from PROFESSIONAL to STUDENT

6.2.1. ProFILE setting sequence

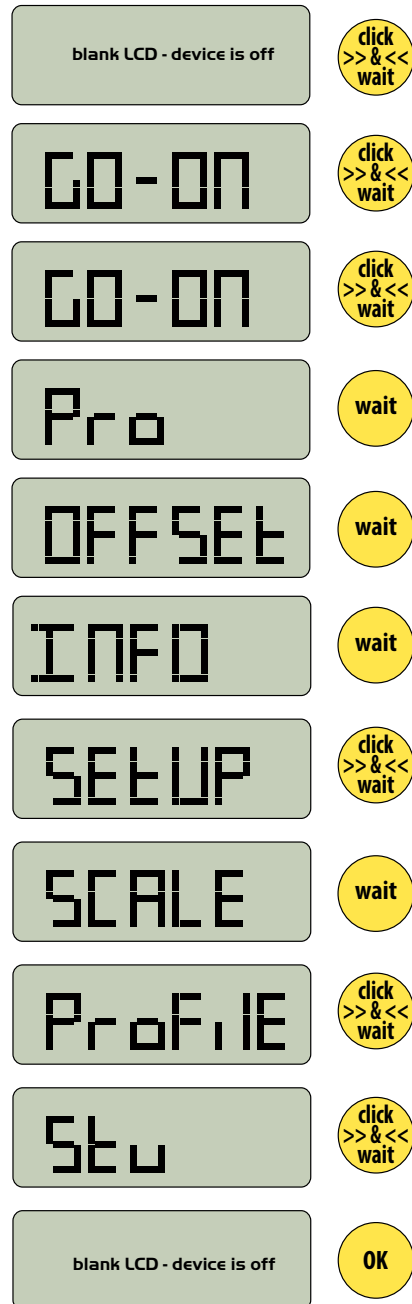

6. SETUP

6.3. AdJUSt setting description

The setting is performed when switching on the device. Briefly press the yellow button on the control unit, GO-ON sign appears (for 2 seconds). **Do not hold the button, depress it only briefly!!!** During the time the GO-ON sign is displayed, immediately after it comes on, depress the yellow button briefly once again. The GO-ON sign appears again. After the yellow button is depressed again (GO-ON sign displayed), the last preset PROFILE can be seen on the display (Stu, Int, Pro, Cpi, Tan). **Do not press** the button to confirm the profile, but wait for the OFFSEt sign to appear, after two seconds the INFO sign appears and after another two seconds the **SETUP** comes on - **confirm by depressing** the button shortly.

SCALE is shown as first, do not confirm, afterwards the ProFIIE comes on, do not confirm. Wait until AdJUSt is displayed, than confirm it by shortly pressing the button. By confirming access to the ADJUSt menu, the individual increases in activation altitude A1 to A9 begin to show in two-second intervals.

Confirm the displayed altitude A by pressing the button. The selected profile and increased activation altitude A1 to A9 are set when the **m² multi** device is switched on again.

Meters/feet are added to the activation altitude of the set profile as follows:

- A1 approx. + 30m / 100ft
- A2 approx. + 60m / 200ft
- A3 approx. + 90m / 300ft
- A4 approx. +120m / 400ft
- A5 approx. +150m / 500ft
- A6 approx. +180m / 600ft
- A7 approx. +210m / 700ft
- A8 approx. +240m / 800ft
- A9 approx. +270m / 900ft

Warning:

ADJUSt changes the altitude lock of the selected profile by the set value A1 - A9

6. SETUP

6.3.1. AdJUST setting sequence with example (setting A2)

Setting the **m² multi** device with Pro profile to AdJUST A2. Standard activation altitude of the Pro profile is **approx. 270m / 885ft**. Adjust A2 adds about **+60m / 200ft**, the activation height will thus be **approx. +330m / 1 085ft**.

The altitude lock increases to about **510m / 1 675ft**

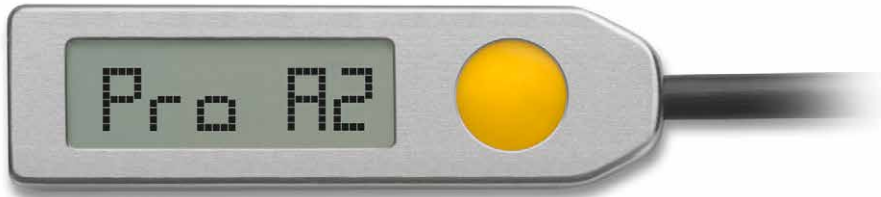

AdJUST setting on + 200ft

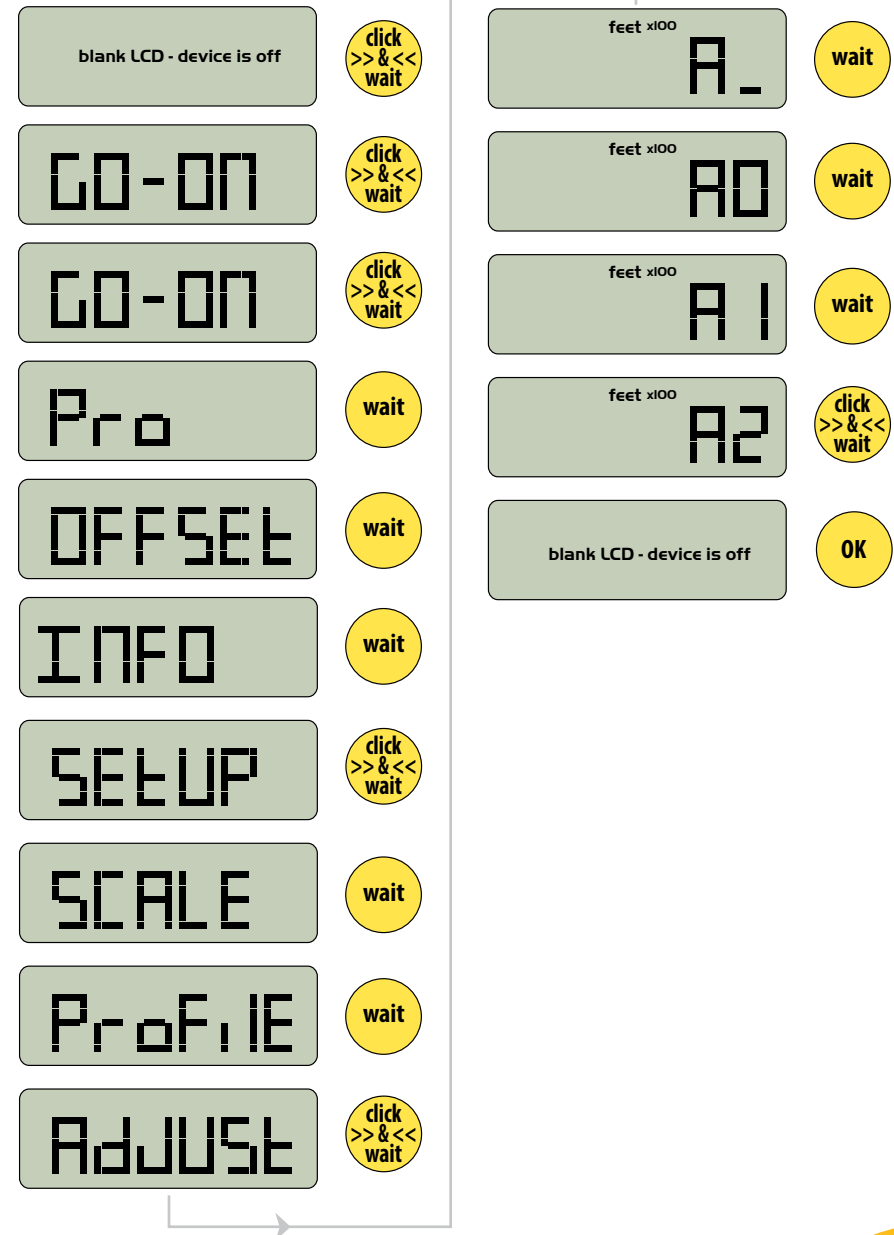

7. Important limits and limit modes

7.1. Use in pressurized aircraft

The **m² multi** can be used in a pressurized aircraft in compliance with the following conditions.

Ambient atmospheric pressure shall be maintained (outside the aircraft) up to **approx. 450m / 1 475ft** above the take-off location for the **m² multi** device profiles STUDENT, INTERMEDIATE, PROFESSIONAL, CANOPY PILOTING and **approx. 900m / 2 950ft** for the device profile TANDEM. The device unlocks at these altitudes. When the device is unlocked, the control unit display shows a colon ":". The icon is used to check that the altitude lock is unlocked. After the altitude lock is unlocked, the aircraft can be pressurized. The aircraft must not be pressurized to a pressure greater than the ambient atmospheric pressure corresponding to **approx. 450m / 1 475ft** or **approx. 900m / 2 950ft**. If there are m² multi devices onboard the aircraft with altitude locks preset to **approx. 450m / 1 475ft** as well as **900m / 2 950ft**, the pilot proceeds according to the rule of pressurizing to ambient atmospheric pressure corresponding to **approx. 900m / 2 950ft**. **If it is not possible to comply with the specified limits, the device may fail! When AdJUST and OFFSEt are used, the limits change depending on the settings!!**

7.2. Altitude lock

The altitude lock is the altitude above landing location related to the device profile and is preset in the device. At the fixed altitude during the climb of the aircraft, the device automatically unlocks to activate the cutter. Only after exceeding this altitude is it possible to activate the cutter. When the altitude lock is unlocked, the control unit display shows a colon ":". The icon is used to check that the altitude lock is unlocked. If the aircraft does not exceed the altitude of the lock, the **m² multi** does not activate the cutter even if the activation parameters are met. Attention!

When using the AdJUST function (Sections 3.5. and 6.3.) the altitude of the lock changes correspondingly!

7.3. Water jumps

The **m² multi** device may be used for (salt as well as fresh) water jumps. The processing unit, control unit and cutter are waterproof to **approx. 2m / 6.5ft** under the surface for 24 hours. The processing unit contains a filter that must be replaced after contact with water. The procedure of replacing the filter can be found in Section 9. Maintenance. We recommend that you leave the filter replacement to your rigger.

7.4. Instructions for the pilot

The altitude protection zone of the **m² multi** device is the first **40m / 130ft** above the aircraft take-off point. These **40m / 130ft** shall be climbed as quickly as possible. At these **40m / 130ft** the **m² multi** recognizes that the aircraft has taken off and transfers from stand by mode to fly mode. After crossing the protection zone **40m / 130ft**, the device must not once again descend below this height until the skydivers leave the aircraft. The only exceptions are cases in which the skydiver's landing location lies at a different altitude than the aircraft take-off location. If such is the case, carefully read the **OFFSEt HI** (Section 4.2.2), the **OFFSEt LO** (Section 4.2.3.) and **AdJUST** function (Sections 3.5. and 6.3.), where the specified **m² multi** modes and functions are illustrated and described in detail.

7. Important limits and limit modes

7.5. Important operation principles

- **Never break or pull on the control unit cable or the cutter cable!**
- **The control button shall only be pressed using your finger pad, never use your nail or any other sharp instrument!**
- **The m² multi device is responsible only for the activation of the cutter according to the specified limits and for cutting reserve parachute closing loop that passes through it. Is not responsible for the proper operation of the entire system of the harness with container, reserve parachute and other equipment and their full functionality!**
- **Never switch on the device on board the aircraft!**
- **The device is operating (armed) only after the altitude lock unlocks. When the device is unlocked, the control unit display shows a colon** 
- **The skydive aircraft must not descend below the landing location altitude plus 40m / 130ft (if it is already above it) until the skydivers exit the aircraft.**
- **If the jump lasted longer than standard (more than 1.5 hours), switch the device off and on again.**
- **If you land outside the airport and are returning, in case of any transport or in case you leave the airport to return, switch off the device and switch it back on only before another jump.**
- **If you accidentally land on a site located about 30m / 100ft above or below the preset landing location, switch the device off after landing and switch it back on only before another jump.**
- **Maintain safe altitude for deploying the main parachute. Avoid falling to the altitude of the device activation zone. This represents a risk of the reserve parachute opening together with the main parachute!**
- **For a flawless function of the system it is necessary to have the correct pilot chute according to the container manufacturer. The closing loops must be closed with the minimum force of 50 N.**
- **When using a high-performance parachute, check the GRAVITY index.**
- **In case the jump is aborted, switch off the m² multi device before descent in the set profile STUDENT. A landing aircraft can easily reach fall rate over 13m.s⁻¹ / 29mph (2 500ft/min).**
- **Avoid strong sources of electromagnetic radiation such as radars, GSM transmitters, walkie-talkies, etc. Never dispose of the used cutter in open fire or common waste. The cutter remains under pressure!**
- **After any contact of the m² multi device with water (or any other liquid), it is always necessary to replace the filter even though the device appears to be functioning properly when dry!**

8. Installation

8.1. Installation procedure

The **m² multi** automatic activation device may be installed in the containers of different manufactures only by a trained person with senior authorization - master rigger or a holder of a comparable equivalent in accordance with the legislation of the country where the **m² multi** will be installed. The **m² multi** automatic activation device must be installed into an original kit supplied by the MarS company and installed in the container directly by the manufacturer of the container and the harness or by an authorized rigger. During the installation, the rigger must always ensure that the cutter, cables, pouches for the **m² multi** body and control and processing units are placed in compliance with the Manual issued by the container and harness manufacturer. When observing the below mentioned principles, the automatic activation device may alternatively be installed into kits by different manufacturers. Before the installation itself, check the device for mechanical damage of its parts, including the cables; make sure that the cutter connector is inserted in the device body and secured with a locking screw. proceed to switch the device on and if everything works correctly, switch it off again. The **m² multi** device body shall be inserted in a pouch sewn to the bottom of the reserve parachute container in such manner that the cables coming from the **m² multi** body are as close to the parachute container bottom as possible. Such installation reduces the load on the cables caused by the pressure of the reserve parachute in a closed - packed parachute container.

The cables of the **m² multi** automatic activation device shall be installed in a given order. **The thin cutter cable always comes first.** If the set for installation of the **m² multi** is attached in such a way that after inserting the **m² multi** body into the pouch, the thin cutter cable is below the thick cable, coil the cables clockwise (when looking from the front). If the set is attached in the opposite way, coil the cable counterclockwise.

Insert the coiled cable into the prepared space so that it lies as close to the container bottom as possible and inside the space closed with a velcro.



8. Installation

The thick cable of the control unit shall always be stowed as second onto the already coiled thin cable. If the m² multi device body is stowed in such a way that the thick cable is above the thin cable, coil the cable counterclockwise (when looking from the front). Otherwise coil the cable in the opposite direction. Both coiled cables shall be fixed by a velcro.

When stowing the cables, it is necessary to avoid sharp breaks, knots and tangling the cables! Stow the cables sufficiently loose as to avoid any tension between the individual parts of the device.

Observe the minimum radius for coiling the cables $r = 25\text{mm}$! Breaking the thick cable may cause damage and result in malfunction of the m² multi!

It is also necessary not to pull on the cable, especially on the control and cutter.

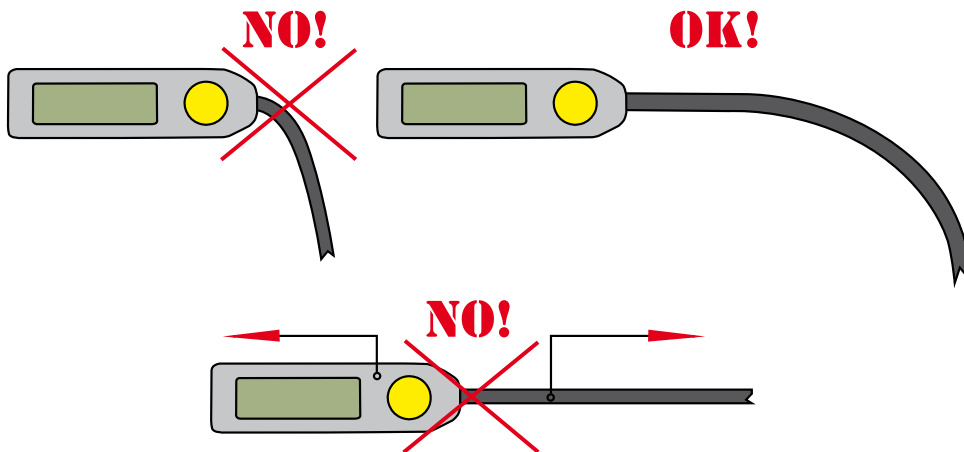
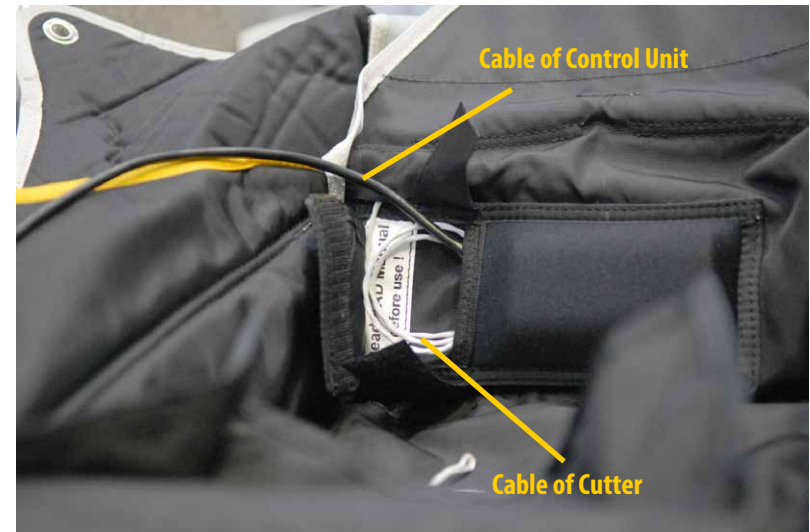

8. Installation

The cables must not be stowed in the pouch determined for the device body, nor shall they be stowed (partially) under the device body. There is a risk of damaging the cables. Stow the cutter and the control unit in accordance with the Manual provided by the container manufacturer so that in both cases there is at least minimum space for the cables. Space for cables reduces the change of damage to the device after packing and during normal use.

Before a complete installation, read the Manual provided by the container manufacturer carefully.



To secure proper function of the m² multi, the closing loop must go through the cutter!

8. Installation

8.2. Securing closing loop

Variation 1

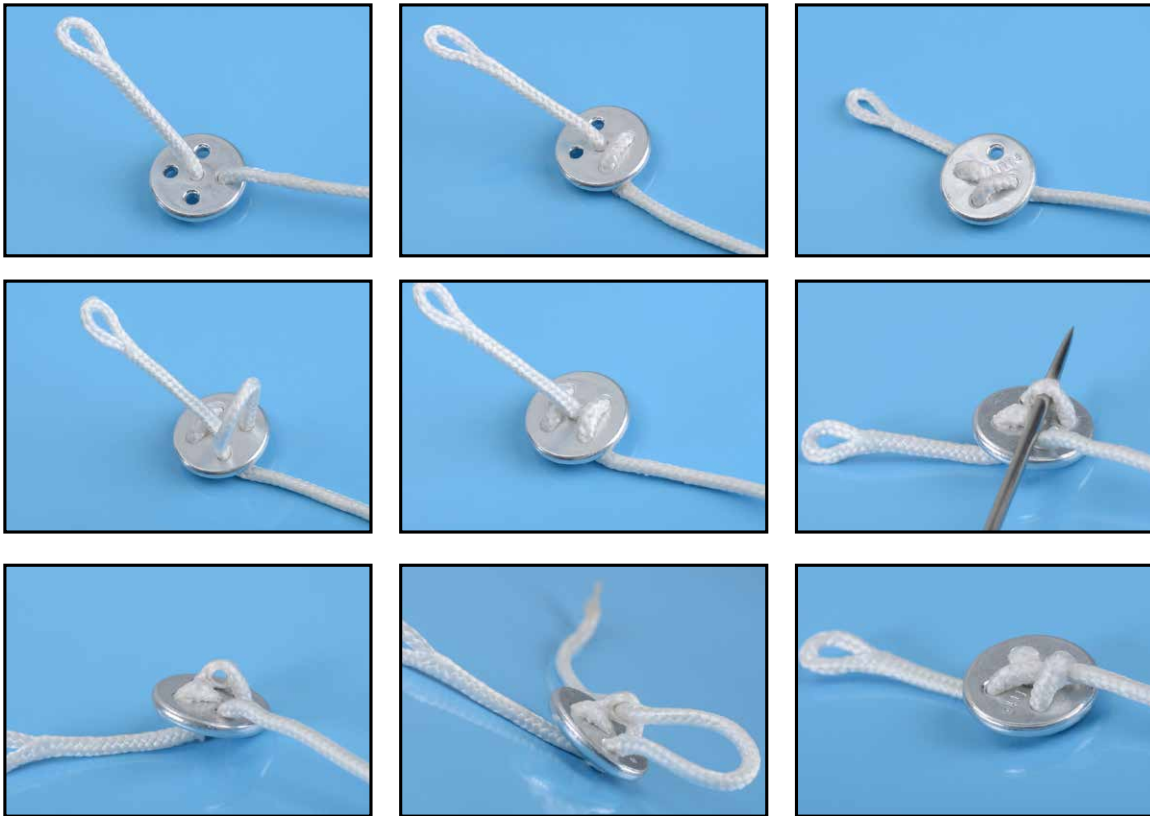

Variation 2

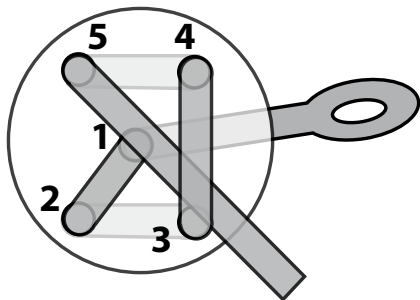
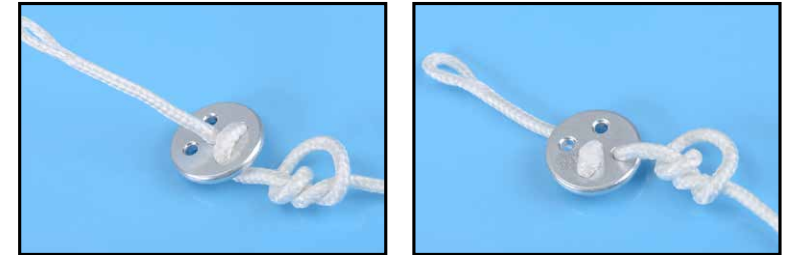

9. Maintenance

9.1. Cutter replacement

If the **m² multi** device has been activated, there are two ways to restore the device:

a) Complete the form in the Manual, provide a detailed description of the event (activation) and send the form along with the **m² multi** device to the address of either the manufacturer MarS a.s. or any authorized dealer to perform an overall analysis. In such case the cutter will be replaced by the manufacturer or authorized dealer and the functional device will be sent back to the user within 14 day of having received the device.

b) Cutter replacement performed by the user or rigger. When replacing the cutter it is always necessary to work with the device turned off; work in a clean and dry environment and follow the instructions below. Use **TORX T8** screwdriver to loosen and remove the locking screw (2) securing the cutter (7) connector (1) to the **m² multi** device body (4). Gently pull and turn the connector (1) in any direction and remove it completely. Make sure that the connecting area on the **m² multi** body (4) is free of dirt and that the old sealing o-ring that was a part of the original connector (1) is removed. Lubricate the o-rings of the new cutter connector (7) (use any silicone gel, including the silicone used to treat the reserve parachute closing loop, - ATTENTION! - apply only a thin layer of the silicone) and check that both o-rings are undamaged and properly placed on the connector. Insert the new cutter (7) connector (1) into the **m² multi** device body (4) by gently pressing and turning the connector (1) in any direction until the connector (1) is completely inserted in the **m² multi** device body (4). Switch on the device to check proper function. If everything works properly, secure the cutter (7) connector (1) to the device body (4) by the locking screw (2). Tighten the screw only slightly. Never use excessive force if you experience a problem loosening the screw. Cool the device in the freezer, the contraction and expansion of various materials will help to loosen the screw. **Never dispose of the used cutter in open fire or common waste. The cutter remains under pressure!**



9. Maintenance

9.2. Filter replacement

After contact with water, it is necessary to replace the air filter built into the **m² multi** device body. The filter serves as a barrier providing protection against contamination. Never use or store the **m² multi** device without a filter. In case the device gets into contact with water, it is necessary to perform the following:

- Immediately switch off the device and remove it from the parachute kit container.
- Rinse the whole device including the cables several times in clean lukewarm water.
- Dry the device, and hang it by its metal body (4).
- Let the cables (3 and 5) hang loose and allow the device to dry completely in the air.
- Remove the old plastic filter (6), use a small screwdriver or pliers. Insert the screwdriver directly into the center of the filter (6) and regardless of any damage to the filter, pull the old filter (6) out of the device body (4).
- Check the filter are (6) for impurities, and if clean insert a new filter (6). It is necessary to insert the filter (6) completely - apply great pressure to hide the filter body inside the **m² multi** device body (4). Only the filter intake tube can protrude outside the device body.
- Switch on the device and check its function.
- Dispose of the used filter in common waste or recycle it together with plastic waste.

After any contact of the m² multi device with water (or any other liquid), it is always necessary to replace the filter even though the device appears to be functioning properly when dry.



9. Maintenance

9.3. Battery

The **m² multi** device is designed to last its whole service life without the need to replace battery. If for any reason the battery fails, it must be replaced by the manufacturer.

In case the battery indicates for example 1 % remaining, there is no need to worry, there is still enough reserve power. 100 % is displayed only the first time the **m² multi** is switched on by the manufacturer.

However, if the “Bat LO” indication appears during calibration and the battery is down to 0 %, do not use the device!

9.4. Annual inspection

The **m² multi** device may undergo a voluntary periodic inspection, usually performed by a rigger during reserve parachute repacking. The inspection and its result may be recorded in the device logbook.

The user is always responsible for the condition, functionality and settings of the device.

9.4.1. Voluntary inspection procedure

1. Visual inspection of the device for any obvious mechanical damage.
 - Check the connecting cables, filter, control unit and cutter.
1. Switch on the unit and allow it to calibrate **(5.2.1)**
 - Once on and calibrated, the device will perform an automatic functionality check. A fully functional device displays the selected profile on the control unit.
2. Once the unit displays the profile **(Stu/Int/Pro/CPi/Tan)**, proceed to the INFO menu by following the instructions in **5.4.1:**
 - Check battery status (under letter “b”).
 - Check the displayed pressure (under letter “P”). The pressure check can be performed by comparison with another accurate device displaying barometric pressure, or with the officially reported current pressure at the airfield. The deviation must not exceed ± 15 hPa.

Display of the current pressure (P) on the m2 multi device is only possible when the device is switched on and calibrated.

(see p. 20, Section 5.2.1).

10. Technical data

10.1. Basic technical data

Total weight.....	approx. 220g
Length, width, height of the processing unit.....	approx. 85mm x 45mm x 23mm
Length, width, height of the control unit.....	approx. 63mm x 18mm x 5mm
Thickness, length of the cutting unit	thickness 8mm x length 55mm
Control unit cable length	approx. 660mm
Cutting unit cable length	approx. 500mm
Working temperature (inside the device).....	approx. from -20 °C / -4 °F to +60 °C / +140 °F
Storage temperature - recommended	approx. from +5 °C / +41 °F to +25 °C / +77 °F
Water resistance.....	24 hours up to 2m / 6.5ft deep
Adjusting landing location altitude.....	approx. +/- 999m / +/- 2,999ft
Operation time	approx. 14 hours from activation
Total service life.....	approx. 15 years + 6 months or 5 000 flight hours or 15 000 jumps (20 minutes per jump)
Range of use under / above sea level	approx. -500m / -1,640ft to +8 000m / +26,200ft

10.2. Device service life

The total service life of the **m² multi** device is 15 years + 6 months from the date of manufacture, or a total of about 5 000 flight hours, which is about 15 000 jumps (maximum 20 minutes per jump start-landing). After the final assembly and complete operation test of each **m² multi** device, the device remains fully functional, including actual deduction of the battery capacity. If during a battery check, a new **m² multi** device displays the current capacity 99 % (INFO, letter “b”, Section 5.4.), the number is correct and DOES NOT IN ANY WAY AFFECT THE GIVEN TOTAL SERVICE LIFE of the **m² multi** device. For a quick and easy check, the device can show the current capacity in %. As long as the capacity is higher than 0 %, the device will always provide reliable function. In case the capacity drops to zero, the device displays a flashing letter “b” (battery) when switched on during calibration. However, the device will still be functional. **Never use the m² multi device with 0% battery capacity!**

10.3. Cutter service life

The cutter service life is **16 years** from the date of manufacture. The cutter is marked with the batch code and the last two digits of the year of manufacture. Never use an expired cutter.

10.4. Warranty

The manufacturer grants a warranty of 24 months from the date of purchase on all parts used in the **m² multi** device and its proper operation within the specified limits. The warranty does not cover damage resulting from normal use of the device, its improper installation or non-standard and rough handling. The manufacturer reserves the right to decide whether to repair or replace the device.

II. Disclaimer

MarS a.s. dedicated great care and attention to the development, laboratory testing, field testing and to the m² multi device properties. The goal was and still is to provide users with maximum comfort and safety when using the automatic activation device. All our efforts are directed to the cutter reliability when cutting the reserve parachute closing loop when its activation criteria are met. Although the device will work properly, it does not guarantee the functionality of the other parts of the parachute kit. The device itself does not exclude the possibility of severe injury or even death. The device is only one of the ways to increase the likelihood of resolving a critical situation the user may find himself in when skydiving. Never rely solely on the automatic activation device. The basis for safe jumps are quality training, appropriate health condition, mental abilities, quality equipment for performing jumps from authorized manufacturers and familiarization with the procedures of dealing with an emergency. Only when these conditions are met, the automatic activation device may help to increase the likelihood of resolving an emergency, if such occurs. The automatic activation device (AAD) is an electronic device and as such may not always work properly even when installed and used properly. Using the appliance only reduces the risk of injury or even death of its user. Shall the user still choose to use the device or provide the device to be used by another person, this act confirms that he is aware of these risks and consequences associated with the use of this device. Even when properly used, the device may cause serious injury or death! by using this device, the user commits to use it as described in this Manual. The manufacturer assumes no liability for damages resulting from non-compliance with the determined procedures.

The manufacturer, MarS a.s assumes no responsibility for any failures and any resulting damage or consequences. If the user is not willing to accept these facts, the manufacturer recommends he does not use the device.

12. Appendices

12.1. X-RAY Card

To Airport Security Personnel:

The device **m² multi** is a parachute emergency opening system for reserve parachute. The **m² multi** is a life saving device for skydivers. Display on the screen (X-ray) may be different depending on the parachute container. All parts of device are not subject to any transport regulations. The **m² multi** parts: 1. central unit, 2. control unit, 3. cutter, 4. control unit cable, 5. cutter cable

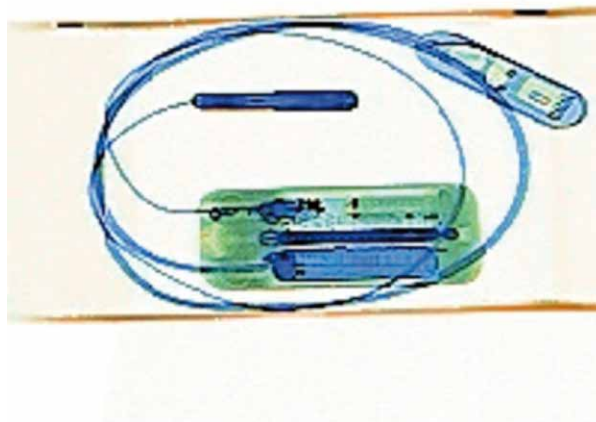
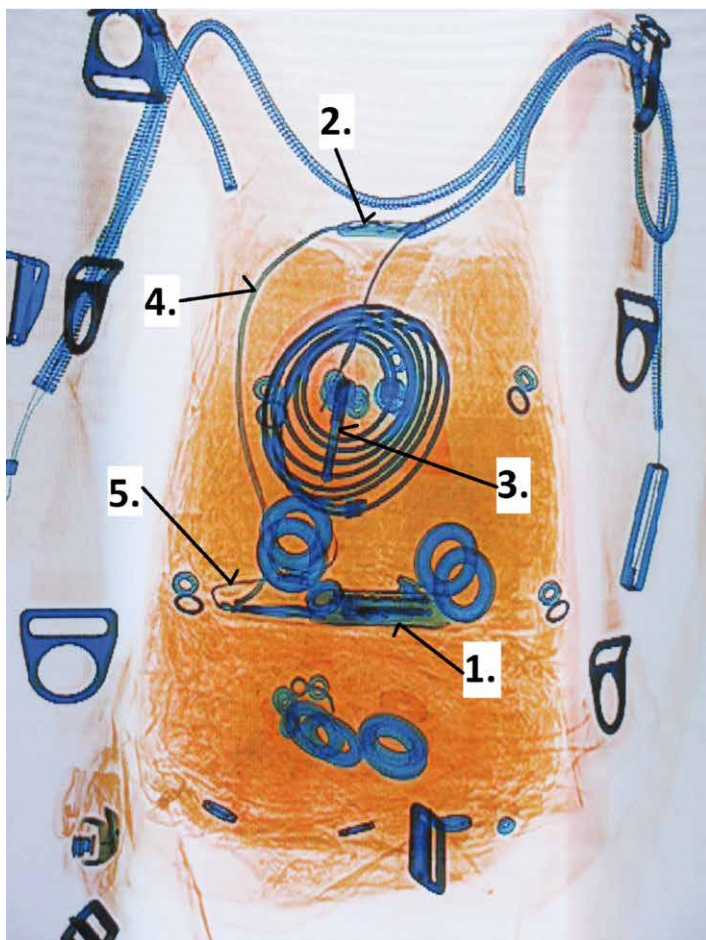

X-ray card

Packed in a box

MarS a.s., Okruzni II 239
569 43 Jevicko, Czech Republic
mars@marsjev.cz
phone +420 461 353 841
www.m2aad.com
www.marsjev.com